

LG styler | Steam Clothing Care



01
02

INTRODUCTION

PRODUCT HISTORY | PRODUCT CATEGORY

2015 LG STYLER

DE-ODOR | DE-WRINKLE & PANTS PRESS |
GENTLE DRY | SANITIZATION |



STYLER STRATEGIC IMPLICATIONS



Styler is a product with a new domain between machinery & service market in Laundry industry. With Styler Product Business as a step stone, LG Washing/Laundry business will expand its biz. Domain & value proposition to meet its own vision of "Total Cleaning Solution Provider".



H&A President
Seongjin, Jo

CUSTOMER NEEDS-BASED LAUNDRY PROCESS

Gathering ... Washing ... Drying ... Ironing ... Packaging & Delivering

LAUNDRY INDUSTRY

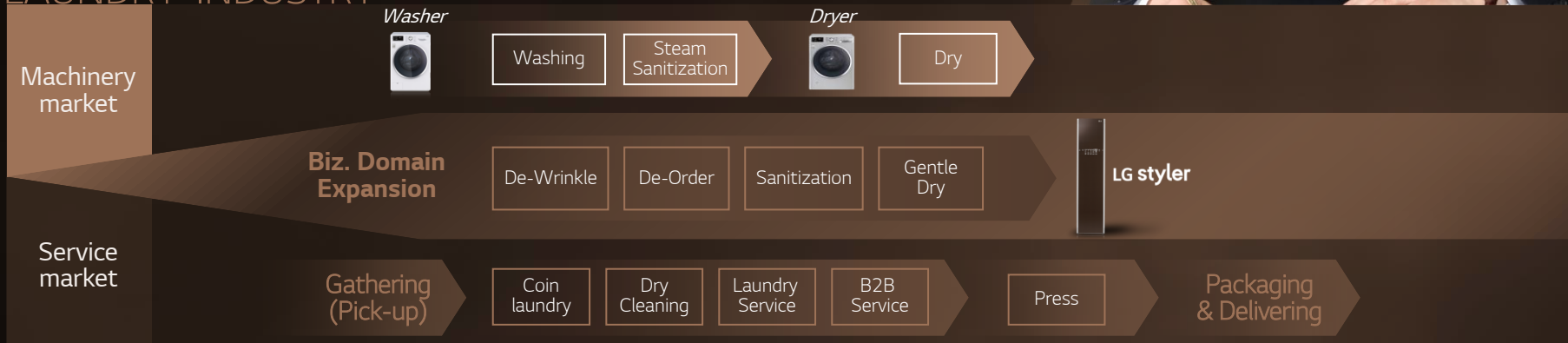

Current LGE Biz. Domain

PRODUCT HISTORY



2011 ●

Launched **WORLD FIRST**

LG styler | Steam
Clothing Care



- 1958 Home application company founded
- 1969 Produced first washing machine in Korea
- 1976 First export of washing machines
- 1998 Launched world first top loader with direct drive motor
- 2000 Launched world first top front with direct drive motor
- 2006 Global introduction of steam washing machine
- 2007 Ranked sales of front loader as number 1 for 5 consecutive years in north America
- 2008 Achieved global no.1 in sales
- 2009 Introduced world first washing machine with 6 motion
- 2010 Launched commercial washer

PRODUCT CATEGORY



"Clothes & Clean Care Solution"
through Newer Technology & Prestigious Design



LG styler | Steam Clothing Care



LG styler

Steam
Clothing Care



Suits, Blouses, Uniforms. Wear it everyday

Why wash it every day?



FRUSTRATED SITUATIONS...

| De-Odor | De-Wrinkle | Pants Press | Gentle Dry | Sanitization |

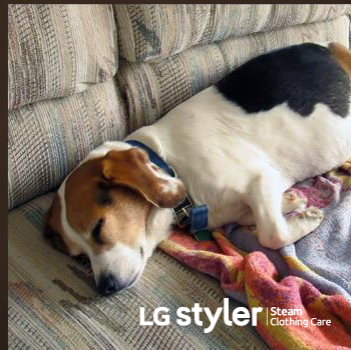

DE-ODOR

I can smell unpleasant odor as I wear my clothes for new season. I thought I put them in the closet last season after Dry Cleaning...



*BBQ-ing...
Smoking Cigars...
My entire clothes smell...*

It's almost time and I need to go out right now. But my clothes are not so neat enough...



REFRESH : DE-ODOR 



With the True Steam™ and deodorizer system,
the LG Styler will help to keep clothes smelling fresh every day.



REFRESH : DE-ODOR

STEP
01

TRUE STEAM™ & SHAKING HANGER

Generate steam and refresh clothes &
By shaking hanger 180 times a minute,
remove the wrinkle and dust



REFRESH : DE-ODOR

STEP 01

TRUE STEAM™ & SHAKING HANGER

Generate steam and refresh clothes &
By shaking hanger 180 times a minute,
remove the wrinkle and dust

STEP 02

AROMA KIT

Insert an aroma sheet to gently infuse
your clothes with scent.





*Do I have to send my clothes
to Dry Cleaners?
It is wrinkled but not even dirty...*



*My Favorite Clothes will
wear out soon,
if I send it to Dry Cleaner so often...*

*I can wear these pants again,
if I can remove those wrinkles...*

DE-WRINKLE PANTS PRESS



REFRESH : DE-WRINKLE & PANTS PRESS

Hang dress trousers flat in the **Styler's pants press**.
It will crease the pants legs in the front
and reduce wrinkles elsewhere.



REFRESH : DE-WRINKLE & PANTS PRESS



HOW TO USE THE PANTS PRESS





*I came through rainy/snowy weather
And my clothes are wet. What shall I do?*

GENTLE DRY

*It drizzles outside and my clothes are little wet.
I want to put them in my closet...*



GENTLE DRY (WITHOUT TUMBLING)



The Styler gently dries clothes or other items that can't be **tumbled dry or need a lower temperature while drying.**

The Styler offers unique clothing care solutions for items that require special attention.

GENTLE DRY (WITHOUT TUMBLING)



**CONVENTIONAL
TUMBLE DRYER**



GENTLE DRY



SANITIZATION



During the standard sanitary course powered by **TrueSteam™**, **LG Styler** helps to reduce allergens.



HOW THE LG STYLER **SANITIZES** CLOTHES



Steam is sprayed on allergens trapped inside fabrics



Allergens are **dissolved**

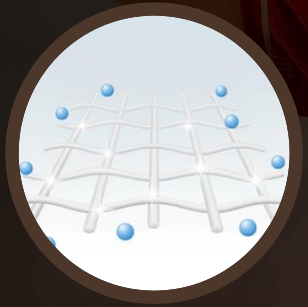

Allergens are **separated** and **removed**



APPLICATION



LIVING ROOM

APPLICATION



BED ROOM



APPLICATION

DRESS ROOM



LG
Life's Good

LG styler | Steam
Clothing Care

APPLICATION



LAUNDRY ROOM



LG stycler Steam
Clothing Care

APPLICATION



MEETING ROOM

APPLICATION



OFFICE



LG stycler | Steam
Clothing Care



DE-ODOR



PANTS PRESS



GENTLE DRY



SANITIZATION

LG STYLER
“STEAM CLOTHING CARE”

LG Brings Styler Steam Closet to Luxury Vacation Rentals

Last week, LG announced that it is partnering with destination club Inspirato to outfit luxury rentals with the latest in cutting-edge LG technology. Through the new partnership, LG plans to outfit 22 select properties with some of its best high-end gear. The Styler, one of our favorite devices at CES 2015 is a dress clothes rejuvenation chamber. You put wrinkled, travel-worn clothes in, and fresh-feeling (and smelling) clothes come out.

2015.01.09

The Closet That Cleans, Irons, and Deodorize Your Clothes

The LG Styler uses steam to eliminate wrinkles and deodorize clothes.

LG Launches Wardrobe Caretaker

LG Styler will gently remove wrinkles with steam and remove 99.9 percent of germs.

LG Styler Event Gives Users Chance To Have Dinner With Lee Min Ho

LG Styler event held on Guangzhou and 5 event participants won a chance to have dinner with Lee Min Ho.

Lee Min Ho Appears At LG Styler Event in Guangzhou

LG H&A nationwide tour in major Chinese cities includes the LG Styler, a unique steam clothing management system. Lee Min-ho made an appearance yesterday at the Guangzhou Shang-ri La Hotel, exciting fans and promoting LG H&A products.

Closet From The Future Cleans, Steams And Presses Your Clothes

LG Styler will gently remove wrinkles with steam and hangers that shake, and will also deodorize clothes.

THANK YOU



STYLER COMPONENTS



Glass Door with Linen Pattern



Anodized Aluminum Frame



Hidden LED Display



Moving Hanger

Slides side to side as clothing bathes in a light mist of steam to release wrinkles effortlessly.

Heat Pump System

Explore energy efficient drying with LG's EcoHybrid technology.

Aroma Kit

Add an optional scent sheet to infuse your clothing with a gentle scent.

True Steam® Nozzle

True Steam® is sprayed from the nozzle to sanitize clothes.



Pants Crease Care

Helps restore pant creases while reducing wrinkles at the knee, waist and everywhere else your pants can wrinkle.
*Only cover up to 38 inch

NFC Cycle Download

Download additional styling cycles to address individual needs. Download up to two new cycles at a time via NFC.

Versatile Rack

Lets you refresh clothes that need to lay flat. Also great for drying hats, gloves and scarves that have been caught in the rain.

Portable Water Container

Makes it easy to fill and drain the water needed for LG's unique True Steam® technology—no water lines needed.

SPECIFICATION



Design, features and specifications subject to change without notice.



[BAF]
Certified Sanitary by
British Allergy Foundation



[INTERTEK]
Detected Sanitary by Intertek



[iF product design award]
2015 iF Product Design Award

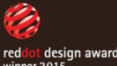

[Reddot design award]
2015 Red Dot Design Award

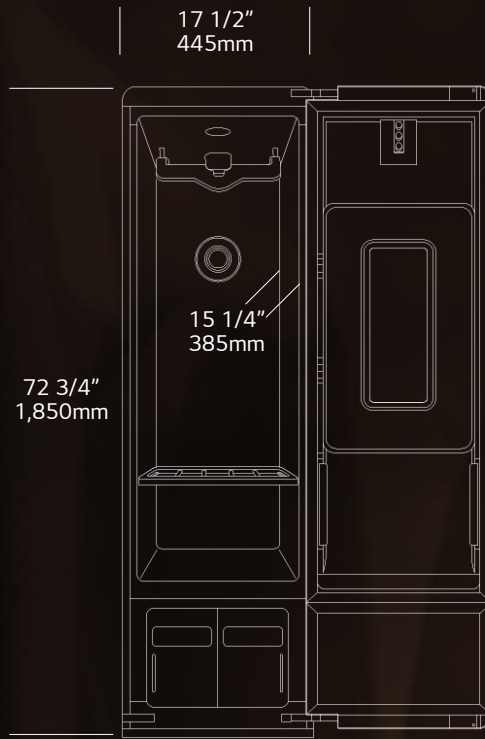

SIZE (mm, W x H x D)	OPTION
445 x 1,850 x 585 17 1/2" x 72 3/4" x 23"	Delay Start Beep (Signal On/Off) One Key Button
REVERSIBLE DOOR	CAPA
Door opening direction can be changed upon installation (Optional)	3(Clothes) + 1 (Pants)
REFRESH TIME	SMART TECH (NFC)
36 Min (Est.)	Cycle Download Smart Diagnosis